

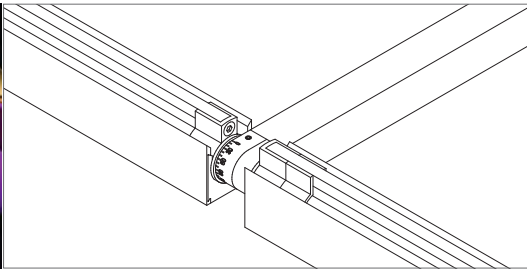

100 Series  
**Modular Light Rail System**  
**VodeRail LED**

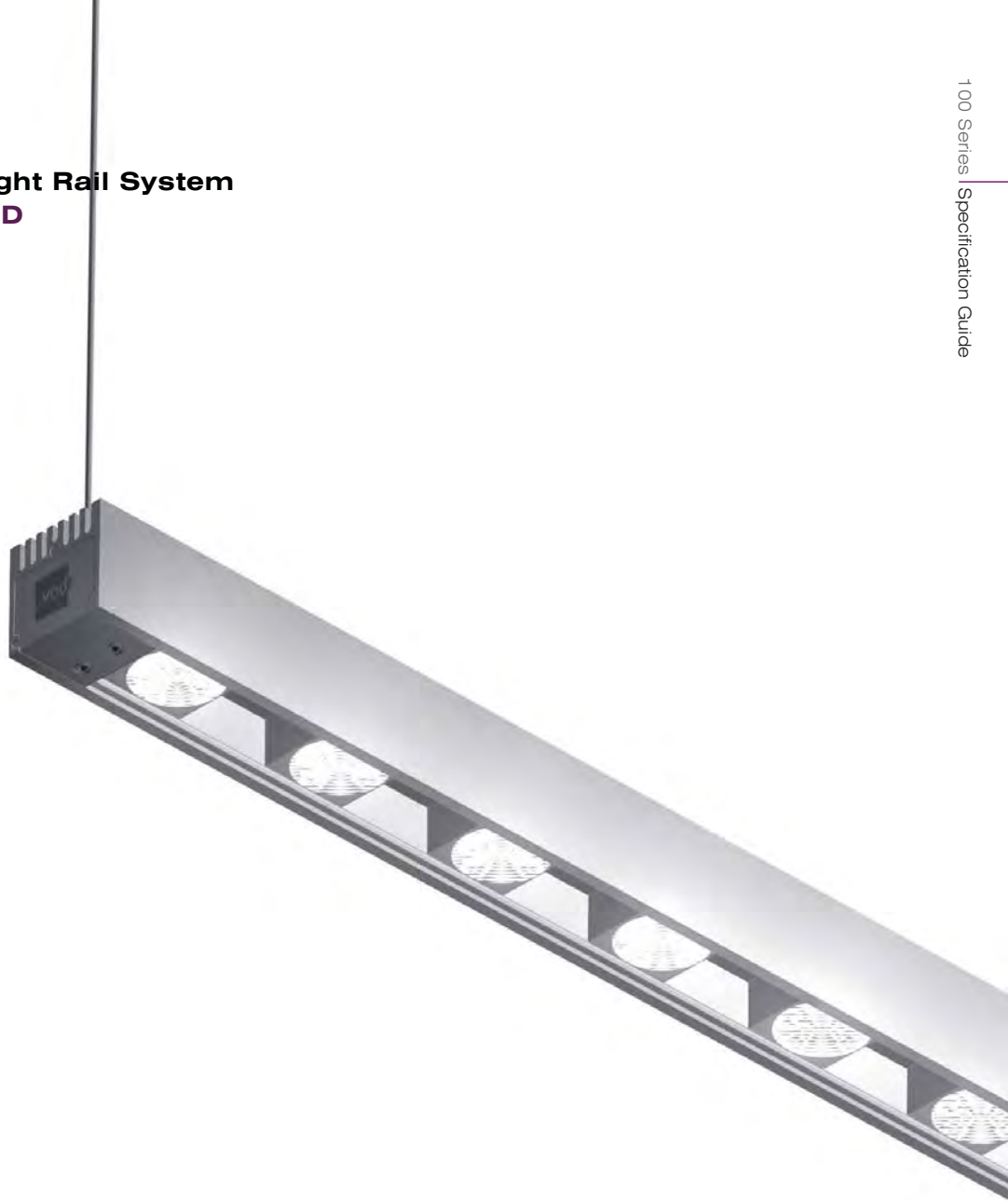

**100 Series MLR System** for LED. Wall, ceiling or table mount. Three rail profiles available. Single or double rail option. 1'(30.5cm) – 6'(182.9cm) lengths depending on lamp and rail type. Quick-connect wiring harness standard. Patented hub design with 370° rotation, angle-gauge and lock-screw. Arm mount or cord suspension. Brushed aluminum finish standard.

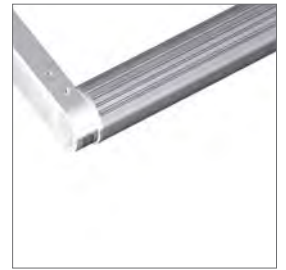

RaceRail



BoxRail



100 Series

### Modular Light Rail System

### VodeRail LED - Example Configuration



8' **Box**Rail LED, 1.75" Arms,  
2" Round Canopy, Remote Ballast

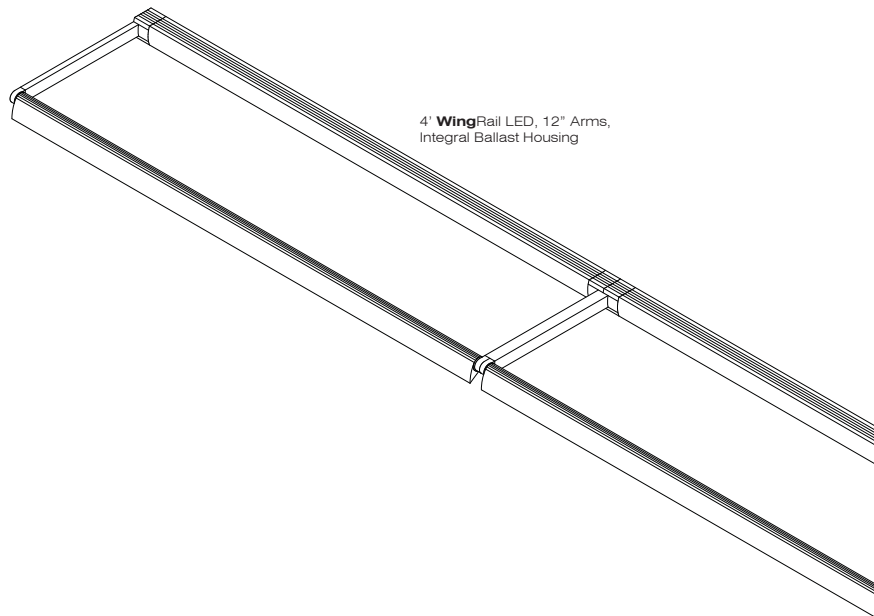

4' **Wing**Rail LED, 12" Arms,  
Integral Ballast Housing

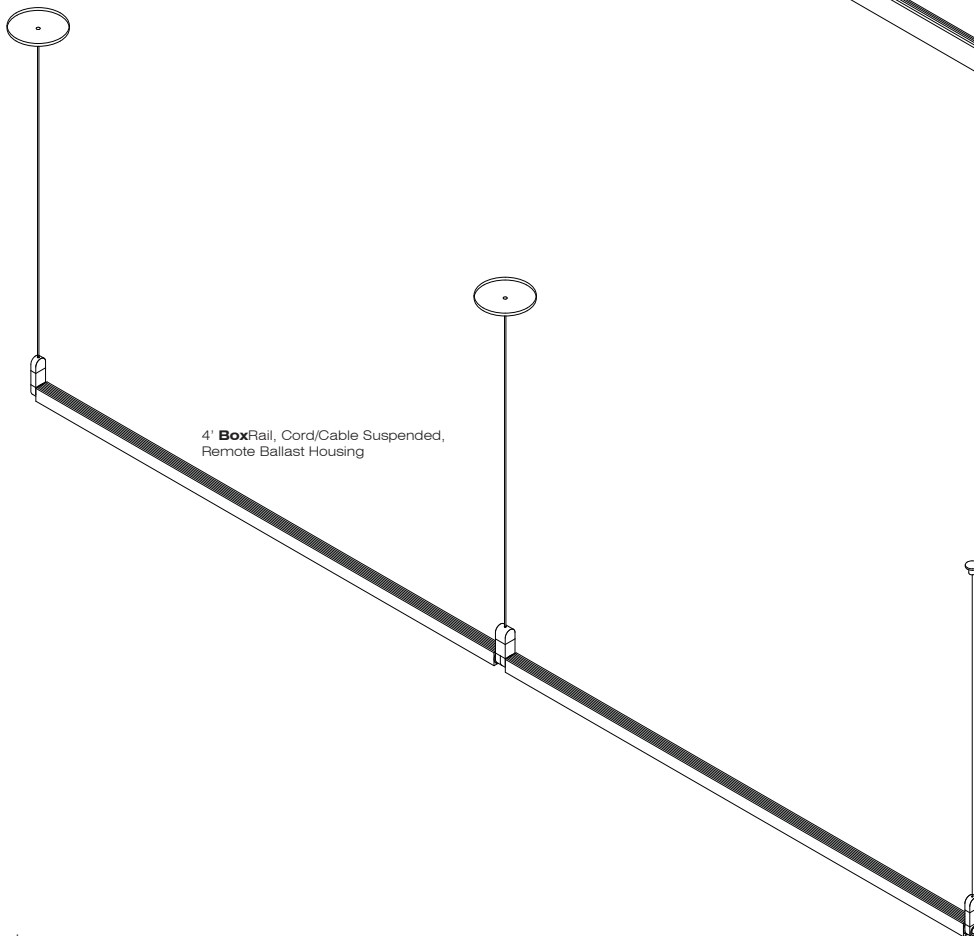

4' **Box**Rail, Cord/Cable Suspended,  
Remote Ballast Housing



100 Series  
**Modular Light Rail System**  
**VodeRail LED - Rail Types**

**VodeRail/LED**

**RaceRail**

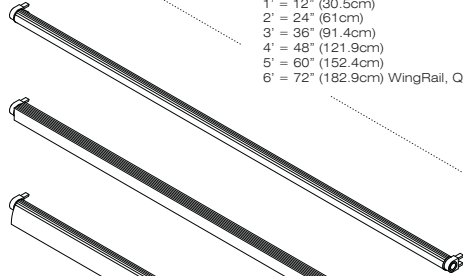

**BoxRail**

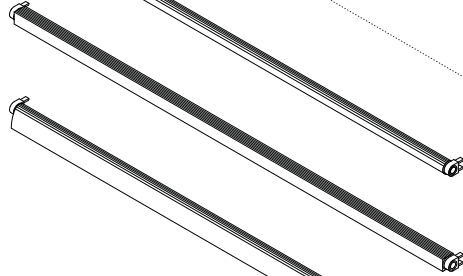

**WingRail**

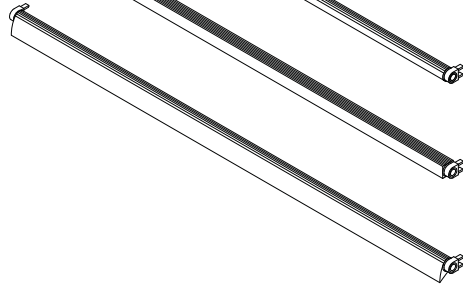

Lengths

- 1' = 12" (30.5cm)
- 2' = 24" (61cm)
- 3' = 36" (91.4cm)
- 4' = 48" (121.9cm)
- 5' = 60" (152.4cm)
- 6' = 72" (182.9cm) WingRail, QueRail, BoxRail, and RaceRail only

Lengths  
2" - 12"  
(5cm - 30.5cm)

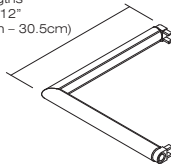

**RaceCorner\***  
(107-CRR-xx-AL)

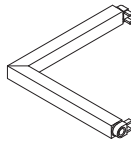

**BoxCorner\***  
(107-CBR-xx-AL)

\*Not an illuminated product.  
\*Must be specified separately from System Specification Code.



100 Series  
**Modular Light Rail System**  
**VodeRail LED - System Components**

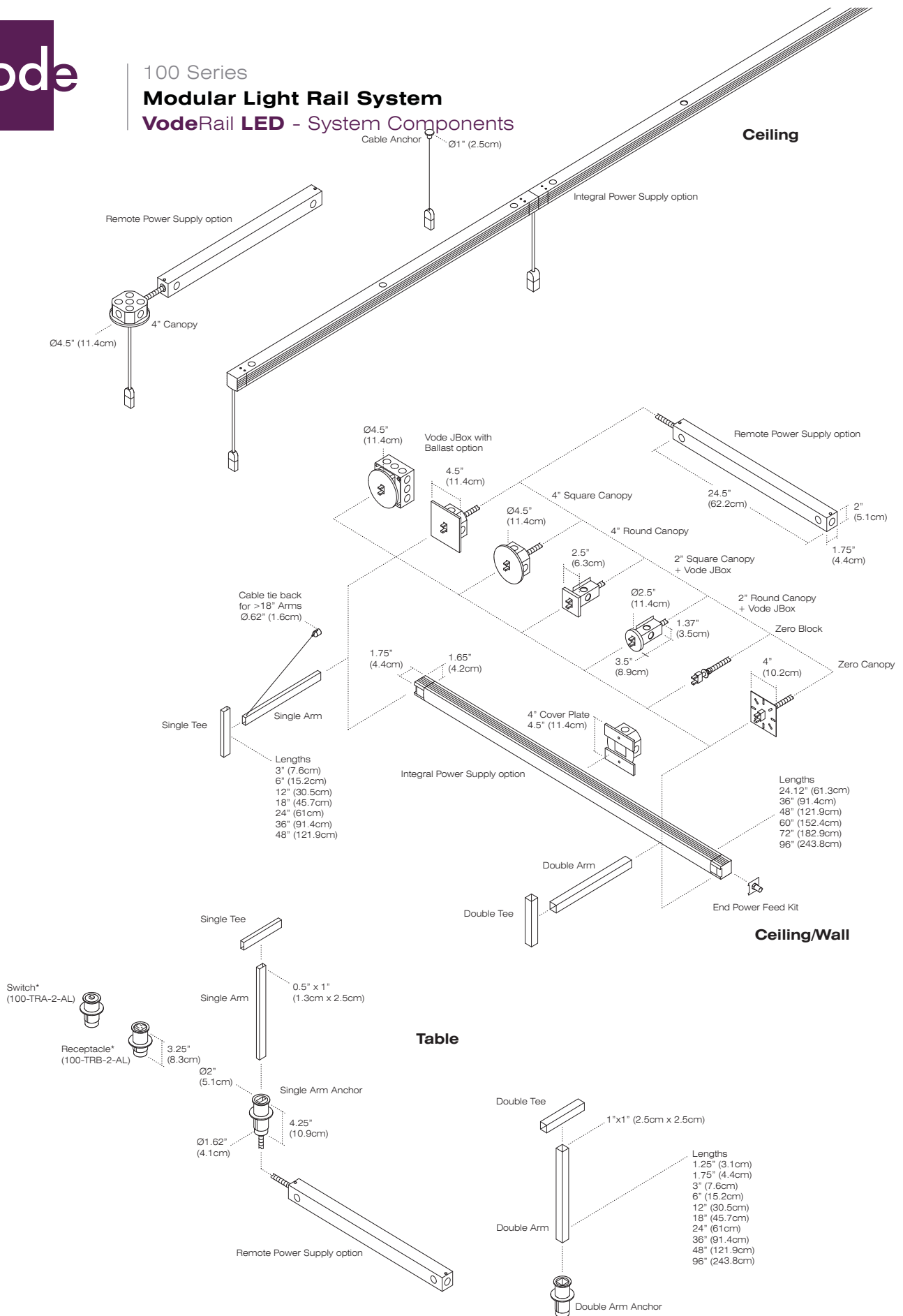

\*Must be specified separately from System Specification Code





All Rail Types  
**Layout Chart**  
**T5 & LED**

Choose length (in feet) and corresponding "A" or "B" layout. "A" and "B" are common layouts.  
 If "A" or "B" layouts are not desired, choose "C" (custom layout) and specify desired layout.

**Please note that 1' rail length is only available with LED.**

**BeeRail and Bee+Rails are limited to 5' lengths. VodeRail/LED is limited to 6'.**

Code	1	2	3	4	5	6	7	8
†1A	1							
2A	2							
3A	3							
4A	4							
4B	2	2						
5A	5							
5B	2	3						
6A	6							
6B	3	3						
7A	4	3						
7B	2	3	2					
*8A	8							
8B	4	4						
9A	3	3	3					
9B	5	4						
10A	5	5						
10B	3	4	3					
11A	4	4	3					
*11B	8	3						
12A	4	4	4					
12B	6	6						
13A	4	5	4					
*13B	8	5						
*14A	6	8						
14B	5	5	4					
15A	5	5	5					
15B	6	6	3					
*16A	8	8						
16B	4	4	4	4				
17A	4	4	4	5				
17B	6	6	5					
18A	6	6	6					
18B	3	3	3	3	3	3		
19A	4	4	4	4	3			
19B	5	5	5	4				
20A	4	4	4	4	4			
20B	5	5	5	5				
21A	4	4	4	4	5			
21B	3	3	3	3	3	3		
22A	4	4	6	4	4			
22B	6	6	6	4				
23A	4	4	4	4	4	3		
23B	6	6	6	5				
*24A	8	8	8					
24B	6	6	6	6				
25A	5	5	5	5	5			
25B	4	4	4	4	4	5		
26A	3	4	4	4	4	4	3	
*26B	6	6	6	8				
27A	6	6	3	6	6			
27B	4	4	4	3	4	4	4	
28A	4	4	4	4	4	4	4	
*28B	8	8	8	4				
*29A	8	8	8	5				
29B	6	6	5	6	6			
30A	6	6	6	6	6			
30B	5	5	5	5	5	5		
*31A	8	5	5	5	8			
31B	4	4	4	4	4	4	4	3
*32A	8	8	8	8				
32B	4	4	4	4	4	4	4	4
33A	6	6	6	6	6	3		
33B	4	5	5	5	5	4		
*34A	5	8	8	8	5			
34B	3	4	4	4	4	4	4	3
35A	5	5	5	5	5	5		

Code	1	2	3	4	5	6	7	8	9	10	11	12	13	14	15	16	17
*35B	8	8	8	8	3												
36A	6	6	6	6	6	6											
36B	4	4	4	4	4	4	4	4									
*37A	8	8	5	8	8												
37B	4	4	4	4	4	4	4	4	5								
*38A	8	8	6	8	8												
*38B	6	6	6	6	6	8											
39A	6	6	6	6	6	6	3										
39B	5	5	5	5	5	5	5	4									
*40A	8	8	8	8	8												
40B	5	5	5	5	5	5	5										
41A	4	4	4	4	4	4	4	4	4	5							
41B	6	6	6	6	6	6	5										
42A	6	6	6	6	6	6	6										
*42B	5	8	8	8	8	5											
*43A	8	8	8	8	8	3											
43B	4	5	5	5	5	5	5	4									
44A	4	4	4	4	4	4	4	4	4	4	4						
*44B	8	8	8	8	8	4											
45A	5	5	5	5	5	5	5	5	5								
*45B	8	8	8	8	8	5											
*46A	8	8	8	8	8	6											
46B	6	6	6	6	6	6	6	4									
*47A	8	8	5	5	5	8	8										
47B	5	5	5	5	5	5	5	4	4	4							
*48A	8	8	8	8	8	8											
48B	6	6	6	6	6	6	6	6									
49A	5	5	5	5	5	5	5	5	4								
49B	6	6	5	5	5	5	5	6	6								
50A	5	5	5	5	5	5	5	5	5	5							
*50B	5	8	8	8	8	5											
51A	6	6	6	6	6	6	6	6	3								
*51B	8	8	8	3	8	8	8										
52A	4	4	4	4	4	4	4	4	4	4	4	4	4	4			
*52B	8	8	8	8	8	8	4										
*53A	8	8	8	5	8	8	8										
53B	4	5	5	5	5	5	5	5	5	5	4						
54A	6	6	6	6	6	6	6	6	6								
*54B	8	8	8	8	8	8	6										
55A	5	5	5	5	5	5	5	5	5	5	5						
*55B	8	8	8	8	8	5	5										
*56A	8	8	8	8	8	8	8										
56B	4	4	4	4	4	4	4	4	4	4	4	4	4	4	4		
57A	6	6	6	6	6	6	6	6	6	3							
*57B	8	8	8	3	3	3	8	8	8								
*58A	5	8	8	8	8	8	5										
58B	6	6	6	6	6	6	6	6	4								
59A	5	5	5	5	5	5	5	5	5	5	5	4					
*59B	8	8	8	8	8	8	8	3									
60A	4	4	4	4	4	4	4	4	4	4	4	4	4	4	4		
60B	6	6	6	6	6	6	6	6	6	6							
*61A	8	8	8	5	8	8	8	8									
61B	4	4	4	4	4	4	4	4	4	4	4	4	4	4	4	5	
*62A	8	8	8	8	8	8	6										
62B	4	6	6	6	6	6	6	6	6	4							
63A	6	6	6	6	6	6	6	6	6	6	3						
63B	4	4	4	4	4	4	4	4	4	4	4	4	4	4	4	3	
*64A	8	8	8	8	8	8	8										
64B	4	4	4	4	4	4	4	4	4	4	4	4	4	4	4	4	
65A	5	5	5	5	5	5	5	5	5	5	5	5	5	5	5		
65B	4	4	4	4	4	4	4	4	4	4	4	4	4	4	4	4	5
66A	6	6	6	6	6	6	6	6	6	6	6						
*66B	5	8	8	8	8	8	8	5									
*67A	8	8	8	8	8	8	8	8	3								
67B	5	5	5	5	5	5	5	5	5	5	5	4	4	4			
*68A	8	8	8	8	8	8	8	8	4								

† available for VodeRail/LED only  
 \* available for VodeRail T5 only



All Rail Types  
**Layout Chart**  
**T5 & LED**

Choose length (in feet) and corresponding "A" or "B" layout. "A" and "B" are common layouts.  
 If "A" or "B" layouts are not desired, choose "C" (custom layout) and specify desired layout.

**Please note that 1' rail length is only available with LED.**

**BeeRail and Bee+Rails are limited to 5' lengths. VodeRail/LED is limited to 6'.**

Code	1	2	3	4	5	6	7	8	9	10	11	12	13	14	15	16	17	18	19	20	21	22	23	24
68B	4	4	4	4	4	4	4	4	4	4	4	4	4	4	4	4								
69A	6	6	6	6	6	6	6	6	6	6	6	6	6	6	6	6	3							
*69B	8	8	8	8	8	8	8	8	8	8	8	5												
*70A	8	8	8	8	8	8	8	8	8	6														
70B	5	5	5	5	5	5	5	5	5	5	5	5	5	5										
*71A	8	5	5	5	5	5	5	5	5	5	5	5	5	5	5	8								
71B	4	4	4	4	4	4	4	4	4	4	4	4	4	4	4	4	4	4	3					
*72A	8	8	8	8	8	8	8	8	8															
72B	6	6	6	6	6	6	6	6	6	6	6	6	6	6	6									
73A	4	4	4	4	4	4	4	4	4	4	4	4	4	4	4	4	4	5						
*73B	8	3	8	8	8	3	8	8	3	8														
*74A	5	8	8	8	8	8	8	8	8	5														
74B	4	6	6	6	6	6	6	6	6	6	6	6	4											
75A	5	5	5	5	5	5	5	5	5	5	5	5	5	5	5	5	5							
75B	6	6	6	6	6	6	6	6	6	6	6	6	6	3										
*76A	8	8	8	8	8	8	8	8	8	4														
76B	4	4	4	4	4	4	4	4	4	4	4	4	4	4	4	4	4	4	4	4				
*77A	8	8	8	8	8	8	8	8	8	5														
77B	4	4	4	4	4	4	4	4	4	4	4	4	4	4	4	4	4	4	5					
78A	6	6	6	6	6	6	6	6	6	6	6	6	6											
*78B	8	8	8	8	8	8	8	8	8	6														
*79A	8	8	8	8	8	8	8	8	5	5														
79B	5	5	5	5	5	5	5	5	5	5	5	5	5	5	5	4								
*80A	8	8	8	8	8	8	8	8	8															
80B	5	5	5	5	5	5	5	5	5	5	5	5	5	5	5	5								
81A	6	6	6	6	6	6	6	6	6	6	6	6	6	3										
81B	4	4	4	4	4	4	4	4	4	4	4	4	4	4	4	4	4	4	5					
*82A	5	8	8	8	8	8	8	8	8	8	5													
82B	6	6	6	6	6	6	6	6	6	6	6	6	6	4										
*83A	8	8	8	8	8	8	8	8	8	3														
83B	4	4	4	4	4	4	4	4	4	4	4	4	4	4	4	4	4	4	3					
84A	6	6	6	6	6	6	6	6	6	6	6	6	6	6										
*84B	8	8	8	8	8	8	8	8	8	4														
85A	5	5	5	5	5	5	5	5	5	5	5	5	5	5	5	5	5							
*85B	8	8	8	8	8	8	8	8	8	5														
*86A	8	8	8	8	8	8	8	8	8	6														
*86B	6	6	6	6	6	6	6	6	6	6	6	6	6	8										
87A	6	6	6	6	6	6	6	6	6	6	6	6	6	3										
*87B	8	8	8	8	8	8	8	8	8	5	5													
*88A	8	8	8	8	8	8	8	8	8	8														
88B	6	6	6	6	6	6	6	6	6	6	6	6	6	4										
*89A	8	8	8	8	8	8	8	8	8	3	3	3												
89B	5	5	5	5	5	5	5	5	5	5	5	5	5	5	5	4								
90A	6	6	6	6	6	6	6	6	6	6	6	6	6	6	6									
90B	5	5	5	5	5	5	5	5	5	5	5	5	5	5	5	5	5							
*91A	8	8	8	8	8	8	8	8	8	8	3													
91B	4	4	4	4	4	4	4	4	4	4	4	4	4	4	4	4	4	4	4	3				
*92A	8	8	8	8	8	8	8	8	8	8	4													
92B	4	6	6	6	6	6	6	6	6	6	6	6	6	4										
93A	6	6	6	6	6	6	6	6	6	6	6	6	6	3										
*93B	8	8	8	8	8	8	8	8	8	8	5													
*94A	8	8	8	8	8	8	8	8	8	8	6													
94B	6	6	6	6	6	6	6	6	6	6	6	6	6	4										
95A	5	5	5	5	5	5	5	5	5	5	5	5	5	5	5	5	5							
*95B	8	8	8	8	8	8	8	8	8	8	5	5												
*96A	8	8	8	8	8	8	8	8	8	8														
96B	6	6	6	6	6	6	6	6	6	6	6	6	6	6	6									
*97A	8	8	8	8	8	8	8	8	8	3	3	3												
97B	4	4	4	4	4	4	4	4	4	4	4	4	4	4	4	4	4	4	4	5				
*98A	5	8	8	8	8	8	8	8	8	8	5													
98B	4	6	6	6	6	6	6	6	6	6	6	6	6	4										
99A	6	6	6	6	6	6	6	6	6	6	6	6	6	3										
*99B	8	8	8	8	8	8	8	8	8	8	3													
*100A	8	8	8	8	8	8	8	8	8	8	4													
100B	5	5	5	5	5	5	5	5	5	5	5	5	5	5	5	5	5							

† available for VodeRail/LED only  
 \* available for VodeRail T5 only